

# 22-23 PAŹDZIERNIKA 2014 X EUROPEJSKIE DNI OSZCZĘDZANIA ENERGII zastosowanie OZE w rozwiązaniach architektonicznych

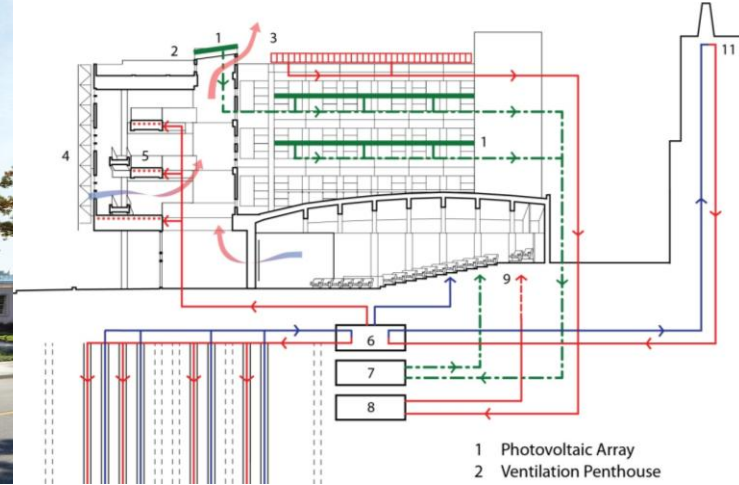



W jaki sposób zastosowanie OZE wpływa na architekturę?  
(\_rozleniwia)





W jaki sposób zastosowanie OZE wpływa na architekturę?  
> wyposażenie

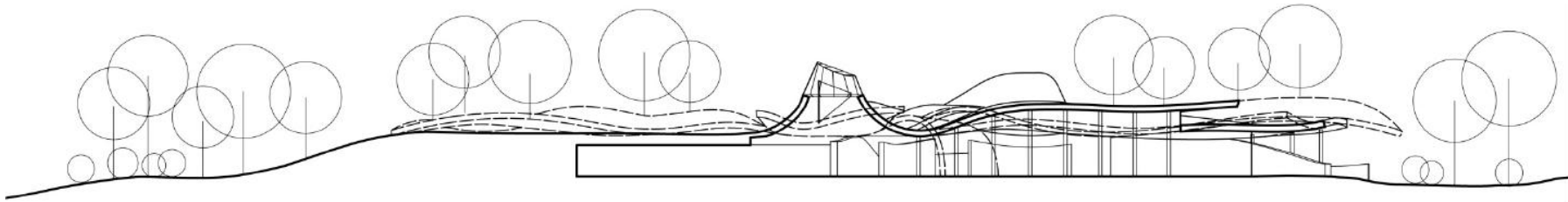

0 5 15 30 50m



**W jaki sposób zastosowanie OZE wpływa na architekturę?**  
**> ukształtowanie**



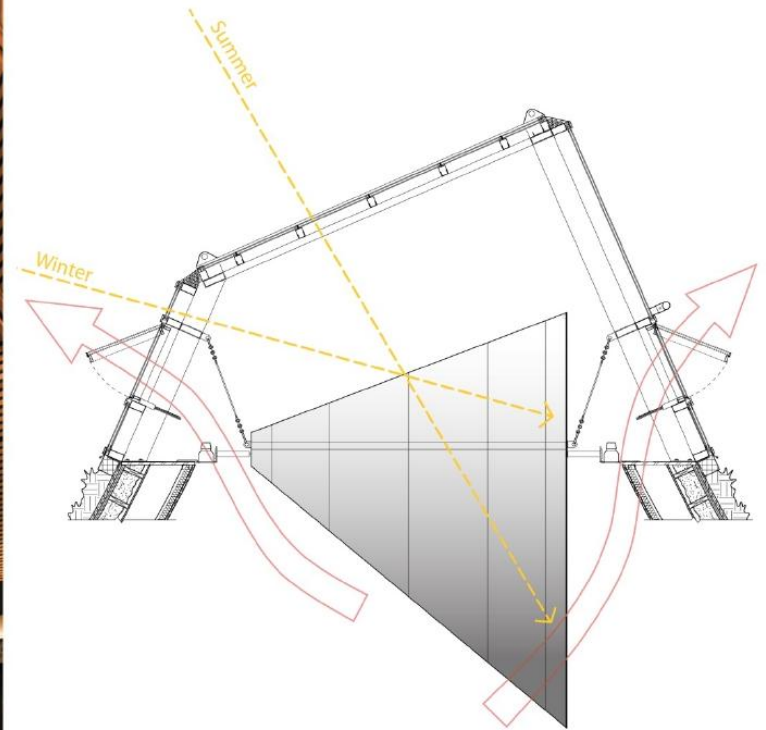

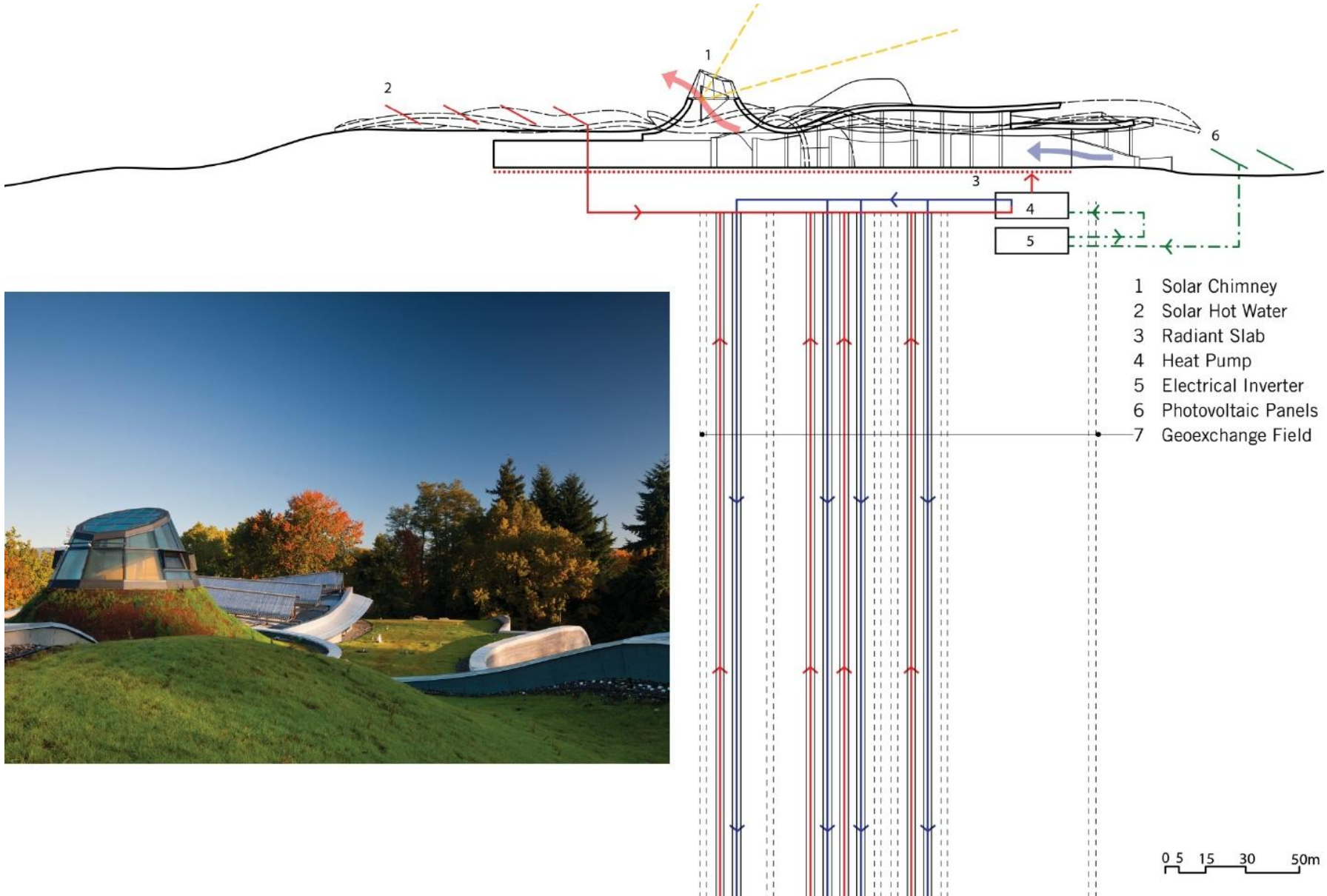

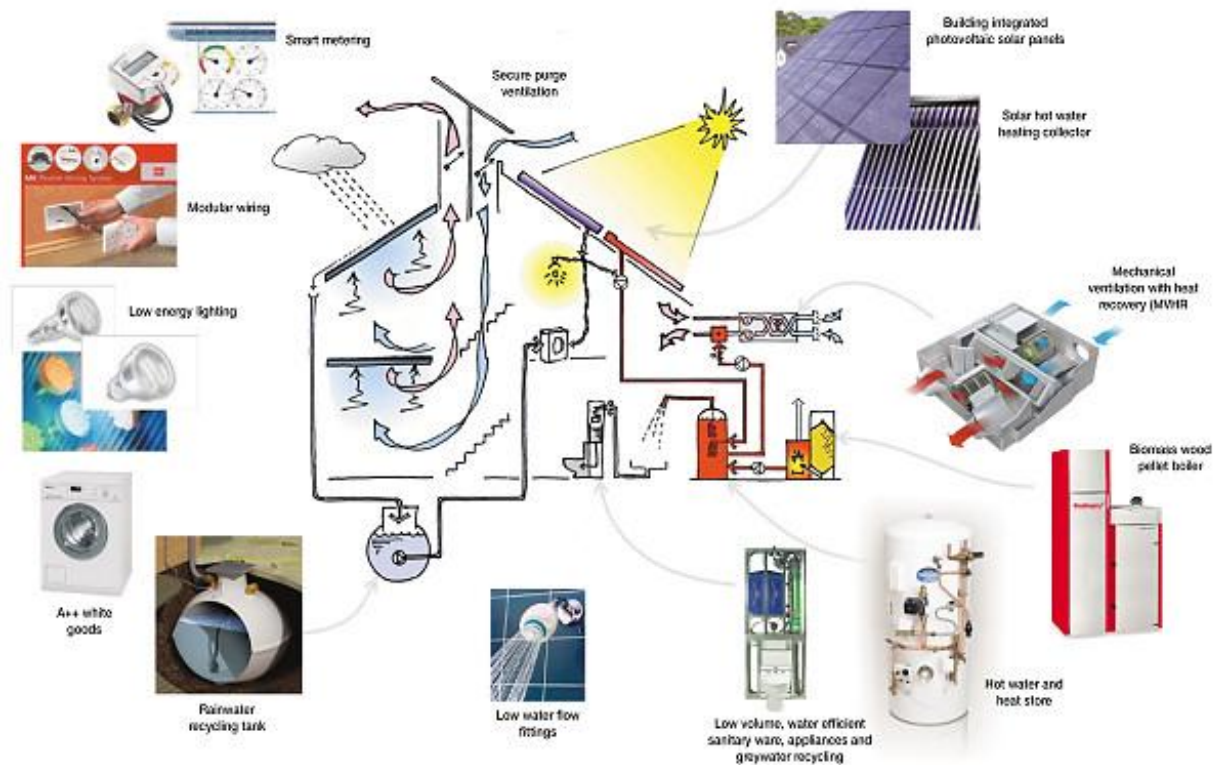

**W jaki sposób zastosowanie OZE wpływa na architekturę?**  
**> myślenie > metodologię > samowystarczalność**



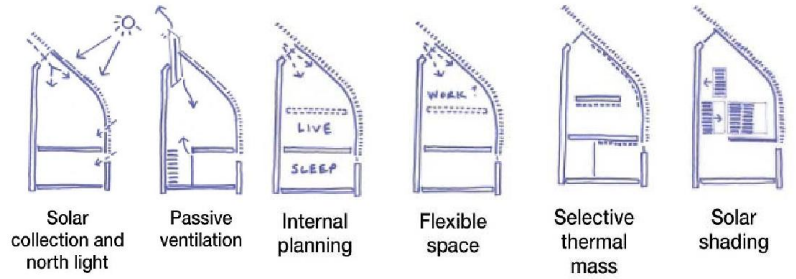
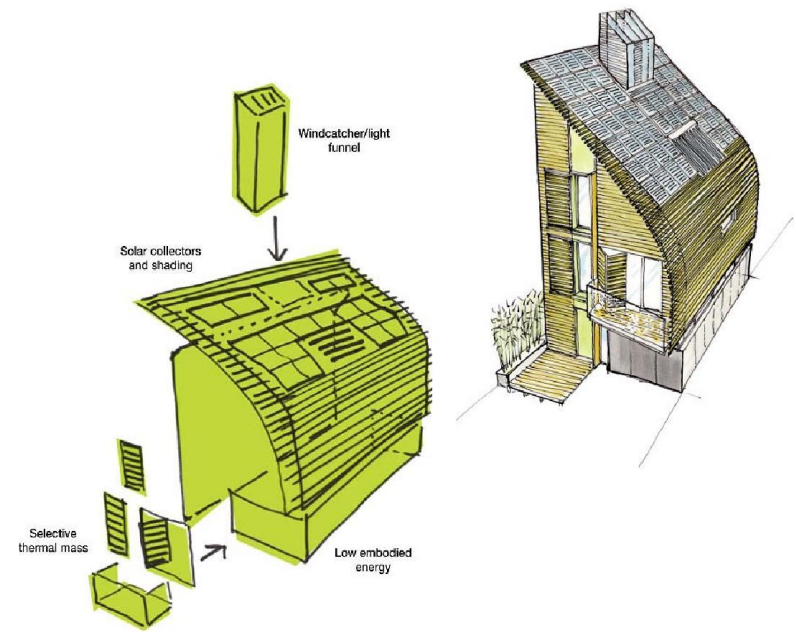



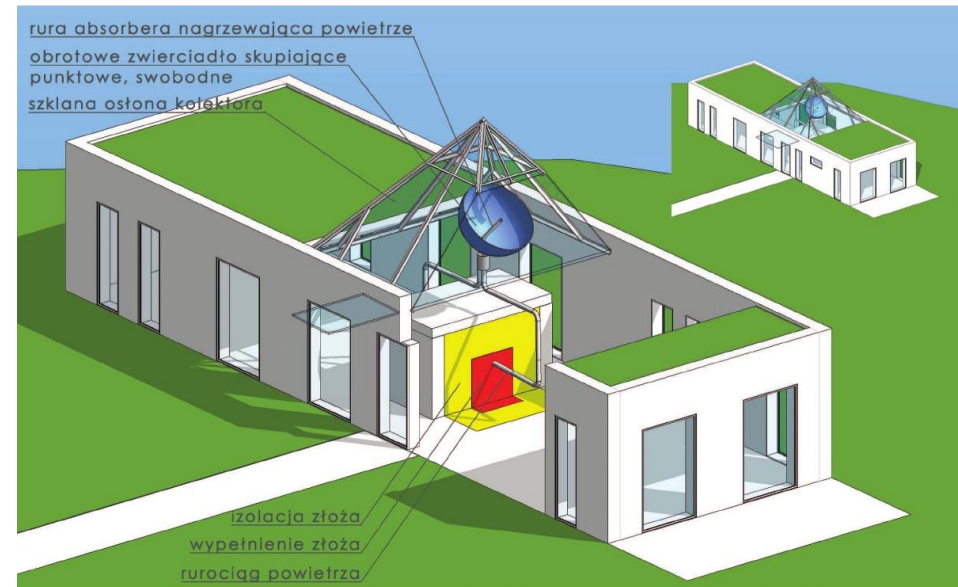

**W jaki sposób zastosowanie OZE wpływa na architekturę?  
> podporządkowanie (off-grid lub on-grid)**



www.docksidegreen.com



Page 5





W jaki sposób zastosowanie OZE wpływa na architekturę?  
> offset > kociołek na biomasę



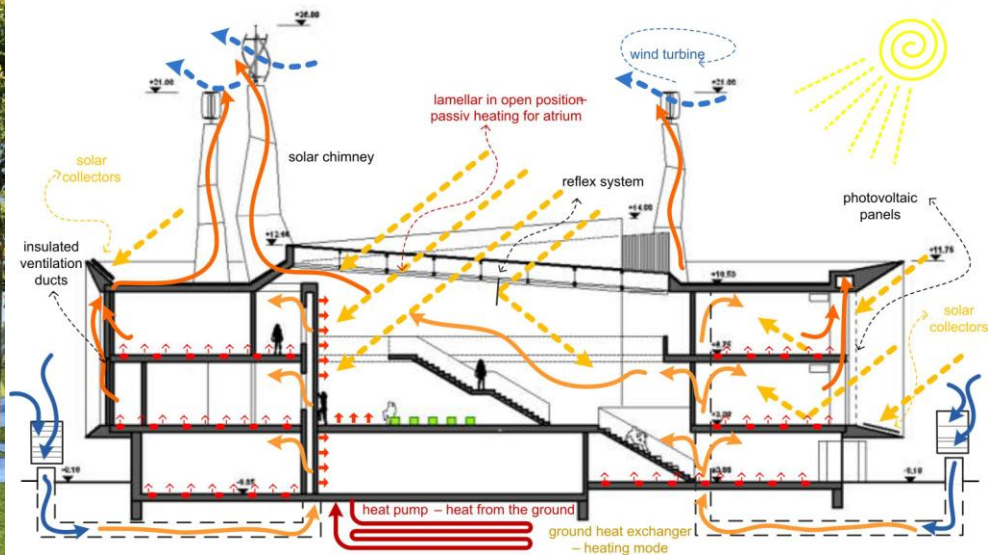

(pseudo) Finansowanie



## 22-23 PAŹDZIERNIKA 2014 X EUROPEJSKIE DNI OSZCZĘDZANIA ENERGII zastosowanie OZE w rozwiązaniach architektonicznych



W jaki sposób zastosowanie OZE wpływa na architekturę?  
> odpowiedzialność